

# ATZ3000 Comprehensive Monitoring Unit User's Manual V1.0



Hangzhou Antin Power Technology Co., Ltd

## Declarations

All rights reserved, without the written permission of the company, any paragraph or chapter content in this manual shall not be excerpted, copied or reproduced or disseminated in any form, otherwise all consequences shall be borne by the violator.

All legal rights reserved.

The Company reserves the right to modify the product specifications described in this manual without prior notice. Before ordering, please contact our company or local agent for the latest specifications of this product.

## Content

Chapter 1 Product Overview .....	- 1 -
1.1 Product Introduction .....	- 1 -
1.2 Product Features .....	- 1 -
1.3 Product Parameters .....	- 2 -
Chapter 2 Technical Specifications .....	- 4 -
2.1 Technical Parameters .....	- 4 -
2.2 Wiring Diagram .....	- 6 -
2.3 Outline/opening dimensions and installation drawings-	7 -
Chapter 3 Operating Instructions .....	- 7 -
3.1 Key Description .....	- 7 -
3.2 Main interface .....	- 8 -
3.3 Display screen .....	- 14 -
3.3.1 U/I menu .....	- 14 -
3.3.2 Power menu .....	- 15 -
3.3.3 Electricity menu .....	- 16 -
3.3.4 Requirements menu .....	- 16 -

3.3.5 Harmonics menu .....	- 16 -
3.3.6 Best Value Menu .....	- 18 -
3.3.7 I/O Menu .....	- 19 -
3.3.8 Rate Menu .....	- 19 -
3.3.9 Setup Menu .....	- 20 -
3.4 Parameter setting menu .....	- 20 -
After-sales service .....	- 25 -

Antin Power

## **Chapter 1 Product Overview**

### **1.1 Product Introduction**

This series of integrated monitoring device is a cost-effective power monitoring instrument developed for low-voltage power systems such as commercial buildings, municipal buildings, industrial automation and residential power consumption. Comprehensive monitoring device with industrial-grade microprocessor as the core, high processing speed, can provide high-precision voltage, current, power, frequency, active power, reactive power, power factor, total harmonics, sub-harmonics, pay rate and other measurements, through the RS-485 communication with the host computer to achieve the exchange of data, you can realize the intelligent management of electric energy. Comprehensive monitoring device adopts modular design, flexible configuration, easy to expand functions. Large dot-matrix liquid crystal display, easy to read data. Comprehensive monitoring device has a wide range of for, can be applied to a variety of intelligent buildings in the field of electricity, industrial power management system and energy efficiency management system, typical applications are: factory power system automation, load control; intelligent building system; power plant electrical DAS; reactive power compensation system.

### **1.2 Product Features**

- Calculation of three-phase power parameters
- Time-based billing with 2 sets of rates and 8 time slots

- Continuous recording of SOE events by time scale
- Power quality can be monitored: harmonic distortion rate, unbalance, phase angle, K-factor
- Adjustable voltage-current ratio
- Support RS-485 communication, MODBUS-RTU protocol
- Adopt AC/DC dual-purpose power supply, high and low voltage isolation
- Dot matrix liquid crystal display

### 1.3 Product Parameters

<b>Measurement and metrology</b>	
Voltage	Phase voltage, line voltage
Current	Three-phase current
Active power	Split-phase and total active power
Reactive power	Split-phase and total reactive power
Apparent power	Split-phase and total apparent power
Power factor	Split-phase and total power factor
Frequency	45-65Hz
<b>Electricity metering</b>	
Active energy	Forward/reverse active energy

Reactive energy	Forward/reverse reactive energy
<b>Communication function</b>	
Communication protocols	MODBUS-RTU
Communication method	RS485

Antin Power

## Chapter 2 Technical Specifications

### 2.1 Technical Parameters

Technical Parameters		norm	
Applicable networks		Three-phase four-wire, three-phase three-wire	
Operating power	Voltage range	AC/DC85~265V	
	Power wastage	<2W	
Accuracy Class		Reactive 1 level, the rest 0.5 level	
Input	Voltage	Rating	AC 100V、220V、400V
		Power wastage	<0.02VA/phase@220V
		(electrical) impedance	≥200kΩ
	Current	Rating	AC 5A(0.02A-5A)
		Overloaded	1.2x continuous, 10x (10s) )
		Power wastage	<0.02VA/phase@5A
		(electrical) impedance	≥0.1Ω
	Frequency		45Hz~65Hz
Communication interface		RS485/Modbus-RTU	
Circumstances	Temperature	Operating Temperature: -25℃~75℃, Storage: -40℃~85℃	
	Humidity	≤95%RH, non-condensing, non-corrosive gas place	



	Height above sea level	≤3000m
EMC Electromagnetic Compatibility	Electrostatic discharge immunity	IV级 (GB/T 17626.2 IEC 61000-4-2)
	Immunity to radiofrequency electromagnetic field radiation	III级 (GB/T 17626.3 IEC 61000-4-3)
	Electrical fast transient pulse group immunity	IV级 (GB/T 17626.4 IEC 61000-4-4)
	Surge immunity	IV级 (GB/T 17626.5 IEC 61000-4-5)
	RF conducted immunity	III级 (GB/T 17626.6 IEC 61000-4-6)
	Work frequency magnetic field immunity	IV级 (GB/T 17626.8 IEC 61000-4-8)
	Oscillatory wave immunity EMI limit values	III级 (GB/T 17626.12 IEC 61000-4-12) In line with (GB/T 14598.16 IEC 60255-25)
Electrical insulation properties	Dielectric strength	2kV frequency voltage, 1 minute (GB/T 13729)
	Electrical insulation resistance	Not less than 100MΩ (GB/T 13729)
	Impulse voltage	5kV, 12/50μs (GB/T 13729)
Mechanical property	Vibration Response/Endurance	I级 (GB/T 11287)
	Shock Response/Endurance	I级 (GB/T 14537)
	Collision Response	I级 (GB/T 14537)

## 2.2 Wiring Diagram

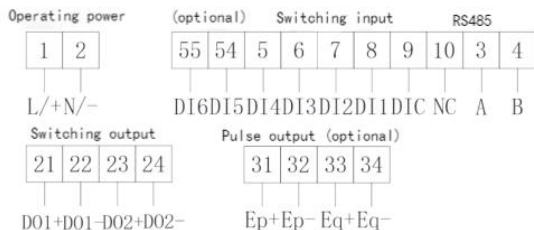

Three-phase four-wire terminal wiring diagram

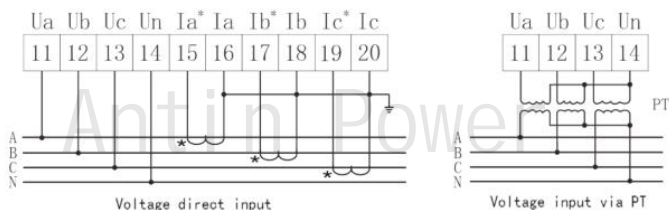

Three-phase three-wire terminal wiring diagram

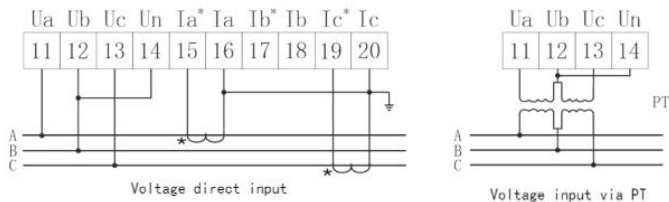

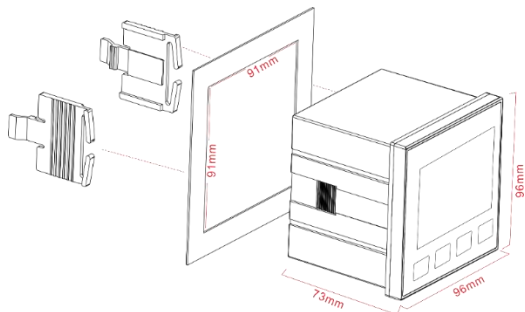

## 2.3 Outline/opening dimensions and installation drawings





## Chapter 3 Operating Instructions

### 3.1 Key Description

Unit has four buttons “**F1**”、“**F2**”、“**F3**”、“**F4**”, Corresponding to the definition of the key and then the bottom line of the LCD screen display, the possible text as follows:

Key contents	Key Meaning
	Left Flip Shift to the left when entering a digit by digit Option changes during parameter setting
	Right Flip

	Refer to "previous page" when browsing parameters, and increase the value when setting parameters.
	Next page" for parameter browsing, decreasing value for parameter setting.
Confirm	When setting parameters, enter the modification state or confirm parameter modification.
Exit	Exit this level of the menu
Textual content (e.g., "U/I," "power," etc.)	Go to the corresponding content submenu

### 3.2 Main interface

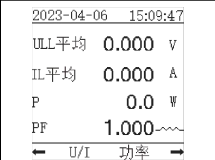
	Display contents of the main interface
---	--

	Level 1 menu	Secondary menu	Three-tier menu
U/I	Phase voltage		
	Line voltage		

	Current		
	In		
	Frequency		
	Voltage angle		
	Current angle		
	Vector graphics		
	U1 waveform		
	U2 waveform		
	U3 waveform		
	I1 waveform		
	I2 waveform		
	I3 waveform		
	Running time		
	Fundamental voltage		
	Fundamental current		
Power	Total power		
	Active power		
	Reactive power		
	Apparent power		
	Power factor		

	Fundamental power factor		
Electricity	Sum of Electricity		
	Active degree of electricity		
	Reactive power		
	Apparent electrode		
Requirement	Maximum demand	Maximum power requirement	
		Maximum current demand	
	Real-time demand	Real-time power demand	
		Current demand in real time	
Harmonic	Fundamental	Total Voltage Harmonics	
		Total current harmonics	
		K-factor	
		Voltage crest factor	

		Unbalance		
		Voltage sequence component		
		Current sequence component		
	Histogram	U1 odd harmonic		
		U2 odd harmonic		
		U3 odd harmonic		
		I1 odd harmonic		
		I2 odd harmonic		
		I3 odd harmonic		
	L1	L1 odd harmonic		
		L1 even harmonic		
	L2	L2 odd harmonic		
		L2 even harmonic		
	L3	L3 odd harmonic		
		L3 even harmonic		
	Best value	Maximum values	U/I	Phase voltage max.
				Line voltage max.
				Maximum value of current
Inc Max				
Power		Maximum active		

			power
			Maximum reactive power
			Maximum apparent power
			Power factor max.
		Harmonic	Maximum value of total voltage harmonics
			Maximum value of total current harmonics
			Maximum K-factor
			Maximum value of the crest factor
	Minimum value	U/I	Phase voltage min.
			Line voltage min.
			Current Minimum
			Inc Min.
	Power	Minimum active power	
		Reactive power min.	



			Apparent power minimum
			Power factor min.
		Harmonic	Voltage total harmonic min.
			Current total harmonic min.
			Minimum value of K-factor
			Crest Factor Min.
I/O	DI status		
	DI pulse counting		
	DO state		
Tariff	Points, peaks, flats, valleys	Active degree of electricity	
	F5、F6、F7、	Reactive power	
	F8	Apparent electrode	
Set up	For detailed functions, please see "Parameter Setting Menu".		

### 3.3 Display screen

#### 3.3.1 U/I menu

Display parameters such as phase voltage, line voltage, current, In, frequency, voltage angle, current angle, vector diagram, U1 waveform, U2 waveform, U3 waveform, I1 waveform, I2 waveform, I3 waveform, running time, fundamental voltage, fundamental current, etc. The specific display interface is as follows:

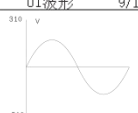
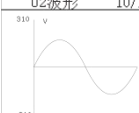
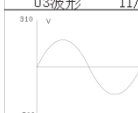
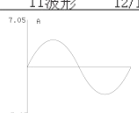
<p>相电压 1/17</p> <p>U1 220.0 V</p> <p>U2 220.0 V</p> <p>U3 220.0 V</p> <p>平均 220.0 V</p> <p>退出 ↑ ↓</p>	<p>线电压 2/17</p> <p>U12 380.0 V</p> <p>U23 380.0 V</p> <p>U31 380.0 V</p> <p>平均 380.0 V</p> <p>退出 ↑ ↓</p>	<p>电流 3/17</p> <p>I1 5.000 A</p> <p>I2 5.000 A</p> <p>I3 5.000 A</p> <p>平均 5.000 A</p> <p>退出 ↑ ↓</p>	<p>In 4/17</p> <p>In 1.000 A</p> <p>退出 ↑ ↓</p>
<p>频率 5/17</p> <p>频率 50.00 Hz</p> <p>退出 ↑ ↓</p>	<p>电压角度 6/17</p> <p>U1 0.0°</p> <p>U2 240.0°</p> <p>U3 120.0°</p> <p>退出 ↑ ↓</p>	<p>电流角度 7/17</p> <p>I1 330.0°</p> <p>I2 180.0°</p> <p>I3 60.0°</p> <p>退出 ↑ ↓</p>	<p>矢量图 8/17</p>  <p>退出 ↑ ↓</p>
<p>U1波形 9/17</p>  <p>退出 ↑ ↓</p>	<p>U2波形 10/17</p>  <p>退出 ↑ ↓</p>	<p>U3波形 11/17</p>  <p>退出 ↑ ↓</p>	<p>I1波形 12/17</p>  <p>退出 ↑ ↓</p>

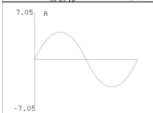
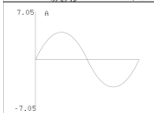
<p>I2波形 13/17</p>  <p>退出 ↑ ↓</p>	<p>I3波形 14/17</p>  <p>退出 ↑ ↓</p>	<p>运行时间 15/17</p> <p>22.5 h</p> <p>退出 ↑ ↓</p>	<p>基波电压 16/17</p> <p>U1 220.0 V</p> <p>U2 220.0 V</p> <p>U3 220.0 V</p> <p>退出 ↑ ↓</p>
<p>基波电流 17/17</p> <p>I1 5.000 A</p> <p>I2 5.000 A</p> <p>I3 5.000 A</p> <p>退出 ↑ ↓</p>			

### 3.3.2 Power menu

Display parameters such as total power, active power, reactive power, apparent power, power factor, base wave power factor, etc. The specific display interface is as follows:

<p>总功率 1/6</p> <p>P 3.300 kW</p> <p>Q 0.0 var</p> <p>S 3.300 kVA</p> <p>PF 1.000 ~~~~</p> <p>退出 ↑ ↓</p>	<p>有功功率 2/6</p> <p>P1 1.100 kW</p> <p>P2 1.100 kW</p> <p>P3 1.100 kW</p> <p>P 3.300 kW</p> <p>退出 ↑ ↓</p>	<p>无功功率 3/6</p> <p>Q1 0.0 var</p> <p>Q2 0.0 var</p> <p>Q3 0.0 var</p> <p>Q 0.0 var</p> <p>退出 ↑ ↓</p>	<p>视在功率 4/6</p> <p>S1 1.100 kVA</p> <p>S2 1.100 kVA</p> <p>S3 1.100 kVA</p> <p>S 3.300 kVA</p> <p>退出 ↑ ↓</p>
<p>功率因数 5/6</p> <p>PF 1.000 ~~~~</p> <p>PF 1.000 ~~~~</p> <p>PF 1.000 ~~~~</p> <p>PF 1.000 ~~~~</p> <p>退出 ↑ ↓</p>	<p>基波功率因数 6/6</p> <p>PF 1.000 ~~~~</p> <p>PF 1.000 ~~~~</p> <p>PF 1.000 ~~~~</p> <p>PF 1.000 ~~~~</p> <p>退出 ↑ ↓</p>		

### 3.3.3 Electricity menu

Displays the parameters of summed degree, active degree, reactive degree, apparent degree, etc. The specific display interface is as follows:

总和电度 1/4		有功电度 2/4		无功电度 3/4		视在电度 4/4	
kWh	0.0	正向	0.0	正向	0.0	总和	0.0
kvarh	0.0	反向	0.0	反向	0.0		
kVAh	0.0	净值	0.0	净值	0.0		
		总和	0.0	总和	0.0		
退出 ↑ ↓		退出 ↑ ↓		退出 ↑ ↓		退出 ↑ ↓	

### 3.3.4 Requirements menu

The demand menu is divided into two sub-menus (maximum, real-time), which display the power demand and current demand, respectively, as follows:

Maximum		Real time	
功率最大需量 1/2		电流最大需量 2/2	
P	15.094 kW		755.0 A
2023-04-06 15:09:47		2023-04-06 15:09:47	
Q	-5.094 var		755.0 A
2023-04-06 15:09:47		2023-04-06 15:09:47	
S	15.094 kVA		755.0 A
2023-04-06 15:09:47		2023-04-06 15:09:47	
退出 ↑ ↓		退出 ↑ ↓	
功率实时需量 1/2		电流实时需量 2/2	
P	0.0 W	I1	0.000 A
Q	0.0 var	I2	0.000 A
S	0.0 VA	I3	0.000 A
退出 ↑ ↓		退出 ↑ ↓	

### 3.3.5 Harmonics menu

The Harmonics menu is divided into five sub-menus (Basic, Histogram, L1, L2, L3), of which "L1", "L2" and "L3" show the odd harmonics and even harmonics, respectively. The details are as follows:

Basic																																																																																																						
<table border="1"> <thead> <tr> <th colspan="2">电压总谐波 1/7</th> </tr> </thead> <tbody> <tr> <td>U1</td> <td>5.75 %</td> </tr> <tr> <td>U2</td> <td>5.34 %</td> </tr> <tr> <td>U3</td> <td>5.74 %</td> </tr> <tr> <td colspan="2">退出 ↑ ↓</td> </tr> </tbody> </table>	电压总谐波 1/7		U1	5.75 %	U2	5.34 %	U3	5.74 %	退出 ↑ ↓		<table border="1"> <thead> <tr> <th colspan="2">电流总谐波 2/7</th> </tr> </thead> <tbody> <tr> <td>I1</td> <td>10.53 %</td> </tr> <tr> <td>I2</td> <td>10.40 %</td> </tr> <tr> <td>I3</td> <td>10.42 %</td> </tr> <tr> <td colspan="2">退出 ↑ ↓</td> </tr> </tbody> </table>	电流总谐波 2/7		I1	10.53 %	I2	10.40 %	I3	10.42 %	退出 ↑ ↓		<table border="1"> <thead> <tr> <th colspan="2">K 因子 3/7</th> </tr> </thead> <tbody> <tr> <td>I1</td> <td>1.245</td> </tr> <tr> <td>I2</td> <td>1.145</td> </tr> <tr> <td>I3</td> <td>1.325</td> </tr> <tr> <td colspan="2">退出 ↑ ↓</td> </tr> </tbody> </table>	K 因子 3/7		I1	1.245	I2	1.145	I3	1.325	退出 ↑ ↓		<table border="1"> <thead> <tr> <th colspan="2">电压波峰因子 4/7</th> </tr> </thead> <tbody> <tr> <td>U1</td> <td>1.453</td> </tr> <tr> <td>U2</td> <td>1.340</td> </tr> <tr> <td>U3</td> <td>1.442</td> </tr> <tr> <td colspan="2">退出 ↑ ↓</td> </tr> </tbody> </table>	电压波峰因子 4/7		U1	1.453	U2	1.340	U3	1.442	退出 ↑ ↓																																																												
电压总谐波 1/7																																																																																																						
U1	5.75 %																																																																																																					
U2	5.34 %																																																																																																					
U3	5.74 %																																																																																																					
退出 ↑ ↓																																																																																																						
电流总谐波 2/7																																																																																																						
I1	10.53 %																																																																																																					
I2	10.40 %																																																																																																					
I3	10.42 %																																																																																																					
退出 ↑ ↓																																																																																																						
K 因子 3/7																																																																																																						
I1	1.245																																																																																																					
I2	1.145																																																																																																					
I3	1.325																																																																																																					
退出 ↑ ↓																																																																																																						
电压波峰因子 4/7																																																																																																						
U1	1.453																																																																																																					
U2	1.340																																																																																																					
U3	1.442																																																																																																					
退出 ↑ ↓																																																																																																						
<table border="1"> <thead> <tr> <th colspan="2">不平衡度 5/7</th> </tr> </thead> <tbody> <tr> <td>电流</td> <td>5.53 %</td> </tr> <tr> <td>电压</td> <td>5.40 %</td> </tr> <tr> <td colspan="2">退出 ↑ ↓</td> </tr> </tbody> </table>	不平衡度 5/7		电流	5.53 %	电压	5.40 %	退出 ↑ ↓		<table border="1"> <thead> <tr> <th colspan="2">电压序分量 6/7</th> </tr> </thead> <tbody> <tr> <td>正序</td> <td>220.0 V</td> </tr> <tr> <td>负序</td> <td>15.40 V</td> </tr> <tr> <td>零序</td> <td>13.40 V</td> </tr> <tr> <td colspan="2">退出 ↑ ↓</td> </tr> </tbody> </table>	电压序分量 6/7		正序	220.0 V	负序	15.40 V	零序	13.40 V	退出 ↑ ↓		<table border="1"> <thead> <tr> <th colspan="2">电流序分量 7/7</th> </tr> </thead> <tbody> <tr> <td>正序</td> <td>5.210 A</td> </tr> <tr> <td>负序</td> <td>0.514 A</td> </tr> <tr> <td>零序</td> <td>0.554 A</td> </tr> <tr> <td colspan="2">退出 ↑ ↓</td> </tr> </tbody> </table>	电流序分量 7/7		正序	5.210 A	负序	0.514 A	零序	0.554 A	退出 ↑ ↓																																																																									
不平衡度 5/7																																																																																																						
电流	5.53 %																																																																																																					
电压	5.40 %																																																																																																					
退出 ↑ ↓																																																																																																						
电压序分量 6/7																																																																																																						
正序	220.0 V																																																																																																					
负序	15.40 V																																																																																																					
零序	13.40 V																																																																																																					
退出 ↑ ↓																																																																																																						
电流序分量 7/7																																																																																																						
正序	5.210 A																																																																																																					
负序	0.514 A																																																																																																					
零序	0.554 A																																																																																																					
退出 ↑ ↓																																																																																																						
Histogram																																																																																																						
<table border="1"> <thead> <tr> <th colspan="2">U1 奇次谐波 1/6</th> </tr> </thead> <tbody> <tr> <td colspan="2"></td> </tr> <tr> <td colspan="2">退出 ↑ ↓</td> </tr> </tbody> </table>	U1 奇次谐波 1/6				退出 ↑ ↓		<table border="1"> <thead> <tr> <th colspan="2">U2 奇次谐波 2/6</th> </tr> </thead> <tbody> <tr> <td colspan="2"></td> </tr> <tr> <td colspan="2">退出 ↑ ↓</td> </tr> </tbody> </table>	U2 奇次谐波 2/6				退出 ↑ ↓		<table border="1"> <thead> <tr> <th colspan="2">U3 奇次谐波 3/6</th> </tr> </thead> <tbody> <tr> <td colspan="2"></td> </tr> <tr> <td colspan="2">退出 ↑ ↓</td> </tr> </tbody> </table>	U3 奇次谐波 3/6				退出 ↑ ↓		<table border="1"> <thead> <tr> <th colspan="2">I1 奇次谐波 4/6</th> </tr> </thead> <tbody> <tr> <td colspan="2"></td> </tr> <tr> <td colspan="2">退出 ↑ ↓</td> </tr> </tbody> </table>	I1 奇次谐波 4/6				退出 ↑ ↓																																																																												
U1 奇次谐波 1/6																																																																																																						
退出 ↑ ↓																																																																																																						
U2 奇次谐波 2/6																																																																																																						
退出 ↑ ↓																																																																																																						
U3 奇次谐波 3/6																																																																																																						
退出 ↑ ↓																																																																																																						
I1 奇次谐波 4/6																																																																																																						
退出 ↑ ↓																																																																																																						
<table border="1"> <thead> <tr> <th colspan="2">I2 奇次谐波 5/6</th> </tr> </thead> <tbody> <tr> <td colspan="2"></td> </tr> <tr> <td colspan="2">退出 ↑ ↓</td> </tr> </tbody> </table>	I2 奇次谐波 5/6				退出 ↑ ↓		<table border="1"> <thead> <tr> <th colspan="2">I3 奇次谐波 6/6</th> </tr> </thead> <tbody> <tr> <td colspan="2"></td> </tr> <tr> <td colspan="2">退出 ↑ ↓</td> </tr> </tbody> </table>	I3 奇次谐波 6/6				退出 ↑ ↓																																																																																										
I2 奇次谐波 5/6																																																																																																						
退出 ↑ ↓																																																																																																						
I3 奇次谐波 6/6																																																																																																						
退出 ↑ ↓																																																																																																						
L1 (L2、L3 the same as L1)																																																																																																						
<table border="1"> <thead> <tr> <th colspan="3">L1 奇次谐波 1/6</th> </tr> </thead> <tbody> <tr> <td>HDx</td> <td>U(%)</td> <td>I(%)</td> </tr> <tr> <td>HD03</td> <td>20.10</td> <td>20.10</td> </tr> <tr> <td>HD05</td> <td>20.10</td> <td>20.10</td> </tr> <tr> <td>HD07</td> <td>20.10</td> <td>20.10</td> </tr> <tr> <td>HD09</td> <td>20.10</td> <td>20.10</td> </tr> <tr> <td>HD11</td> <td>20.10</td> <td>20.10</td> </tr> <tr> <td>HD13</td> <td>20.10</td> <td>20.10</td> </tr> <tr> <td colspan="3">退出 ↑ ↓</td> </tr> </tbody> </table>	L1 奇次谐波 1/6			HDx	U(%)	I(%)	HD03	20.10	20.10	HD05	20.10	20.10	HD07	20.10	20.10	HD09	20.10	20.10	HD11	20.10	20.10	HD13	20.10	20.10	退出 ↑ ↓			<table border="1"> <thead> <tr> <th colspan="3">L1 奇次谐波 2/6</th> </tr> </thead> <tbody> <tr> <td>HDx</td> <td>U(%)</td> <td>I(%)</td> </tr> <tr> <td>HD15</td> <td>20.10</td> <td>20.10</td> </tr> <tr> <td>HD17</td> <td>20.10</td> <td>20.10</td> </tr> <tr> <td>HD19</td> <td>20.10</td> <td>20.10</td> </tr> <tr> <td>HD21</td> <td>20.10</td> <td>20.10</td> </tr> <tr> <td>HD23</td> <td>20.10</td> <td>20.10</td> </tr> <tr> <td>HD25</td> <td>20.10</td> <td>20.10</td> </tr> <tr> <td colspan="3">退出 ↑ ↓</td> </tr> </tbody> </table>	L1 奇次谐波 2/6			HDx	U(%)	I(%)	HD15	20.10	20.10	HD17	20.10	20.10	HD19	20.10	20.10	HD21	20.10	20.10	HD23	20.10	20.10	HD25	20.10	20.10	退出 ↑ ↓			<table border="1"> <thead> <tr> <th colspan="3">L1 奇次谐波 3/6</th> </tr> </thead> <tbody> <tr> <td>HDx</td> <td>U(%)</td> <td>I(%)</td> </tr> <tr> <td>HD27</td> <td>20.10</td> <td>20.10</td> </tr> <tr> <td>HD29</td> <td>20.10</td> <td>20.10</td> </tr> <tr> <td>HD31</td> <td>20.10</td> <td>20.10</td> </tr> <tr> <td colspan="3">退出 ↑ ↓</td> </tr> </tbody> </table>	L1 奇次谐波 3/6			HDx	U(%)	I(%)	HD27	20.10	20.10	HD29	20.10	20.10	HD31	20.10	20.10	退出 ↑ ↓			<table border="1"> <thead> <tr> <th colspan="3">L1 偶次谐波 4/6</th> </tr> </thead> <tbody> <tr> <td>HDx</td> <td>U(%)</td> <td>I(%)</td> </tr> <tr> <td>HD02</td> <td>20.10</td> <td>20.10</td> </tr> <tr> <td>HD04</td> <td>20.10</td> <td>20.10</td> </tr> <tr> <td>HD06</td> <td>20.10</td> <td>20.10</td> </tr> <tr> <td>HD08</td> <td>20.10</td> <td>20.10</td> </tr> <tr> <td>HD10</td> <td>20.10</td> <td>20.10</td> </tr> <tr> <td>HD12</td> <td>20.10</td> <td>20.10</td> </tr> <tr> <td colspan="3">退出 ↑ ↓</td> </tr> </tbody> </table>	L1 偶次谐波 4/6			HDx	U(%)	I(%)	HD02	20.10	20.10	HD04	20.10	20.10	HD06	20.10	20.10	HD08	20.10	20.10	HD10	20.10	20.10	HD12	20.10	20.10	退出 ↑ ↓		
L1 奇次谐波 1/6																																																																																																						
HDx	U(%)	I(%)																																																																																																				
HD03	20.10	20.10																																																																																																				
HD05	20.10	20.10																																																																																																				
HD07	20.10	20.10																																																																																																				
HD09	20.10	20.10																																																																																																				
HD11	20.10	20.10																																																																																																				
HD13	20.10	20.10																																																																																																				
退出 ↑ ↓																																																																																																						
L1 奇次谐波 2/6																																																																																																						
HDx	U(%)	I(%)																																																																																																				
HD15	20.10	20.10																																																																																																				
HD17	20.10	20.10																																																																																																				
HD19	20.10	20.10																																																																																																				
HD21	20.10	20.10																																																																																																				
HD23	20.10	20.10																																																																																																				
HD25	20.10	20.10																																																																																																				
退出 ↑ ↓																																																																																																						
L1 奇次谐波 3/6																																																																																																						
HDx	U(%)	I(%)																																																																																																				
HD27	20.10	20.10																																																																																																				
HD29	20.10	20.10																																																																																																				
HD31	20.10	20.10																																																																																																				
退出 ↑ ↓																																																																																																						
L1 偶次谐波 4/6																																																																																																						
HDx	U(%)	I(%)																																																																																																				
HD02	20.10	20.10																																																																																																				
HD04	20.10	20.10																																																																																																				
HD06	20.10	20.10																																																																																																				
HD08	20.10	20.10																																																																																																				
HD10	20.10	20.10																																																																																																				
HD12	20.10	20.10																																																																																																				
退出 ↑ ↓																																																																																																						

<table border="1"> <thead> <tr> <th colspan="3">L1 偶次谐波 5/6</th> </tr> <tr> <th>HDx</th> <th>U(%)</th> <th>I(%)</th> </tr> </thead> <tbody> <tr> <td>HD14</td> <td>20.10</td> <td>20.10</td> </tr> <tr> <td>HD16</td> <td>20.10</td> <td>20.10</td> </tr> <tr> <td>HD18</td> <td>20.10</td> <td>20.10</td> </tr> <tr> <td>HD20</td> <td>20.10</td> <td>20.10</td> </tr> <tr> <td>HD22</td> <td>20.10</td> <td>20.10</td> </tr> <tr> <td>HD24</td> <td>20.10</td> <td>20.10</td> </tr> </tbody> </table>	L1 偶次谐波 5/6			HDx	U(%)	I(%)	HD14	20.10	20.10	HD16	20.10	20.10	HD18	20.10	20.10	HD20	20.10	20.10	HD22	20.10	20.10	HD24	20.10	20.10	<table border="1"> <thead> <tr> <th colspan="3">L1 偶次谐波 6/6</th> </tr> <tr> <th>HDx</th> <th>U(%)</th> <th>I(%)</th> </tr> </thead> <tbody> <tr> <td>HD26</td> <td>20.10</td> <td>20.10</td> </tr> <tr> <td>HD28</td> <td>20.10</td> <td>20.10</td> </tr> <tr> <td>HD30</td> <td>20.10</td> <td>20.10</td> </tr> </tbody> </table>	L1 偶次谐波 6/6			HDx	U(%)	I(%)	HD26	20.10	20.10	HD28	20.10	20.10	HD30	20.10	20.10		
L1 偶次谐波 5/6																																										
HDx	U(%)	I(%)																																								
HD14	20.10	20.10																																								
HD16	20.10	20.10																																								
HD18	20.10	20.10																																								
HD20	20.10	20.10																																								
HD22	20.10	20.10																																								
HD24	20.10	20.10																																								
L1 偶次谐波 6/6																																										
HDx	U(%)	I(%)																																								
HD26	20.10	20.10																																								
HD28	20.10	20.10																																								
HD30	20.10	20.10																																								
退出 ↑ ↓	退出 ↑ ↓																																									

### 3.3.6 Best Value Menu

Maximum menu is divided into two submenus (maximum, minimum), "maximum" and "minimum" below the three levels of the same menu, respectively, to display the U/I, power, harmonics, the specific content is as follows:

U/I																																																																											
<table border="1"> <thead> <tr> <th colspan="2">相电压最大值 1/4</th> </tr> </thead> <tbody> <tr> <td>U1</td> <td>220.0 V</td> </tr> <tr> <td>2023-04-06 15:09:47</td> <td></td> </tr> <tr> <td>U2</td> <td>220.0 V</td> </tr> <tr> <td>2023-04-06 15:09:47</td> <td></td> </tr> <tr> <td>U3</td> <td>220.0 V</td> </tr> <tr> <td>2023-04-06 15:09:47</td> <td></td> </tr> </tbody> </table>	相电压最大值 1/4		U1	220.0 V	2023-04-06 15:09:47		U2	220.0 V	2023-04-06 15:09:47		U3	220.0 V	2023-04-06 15:09:47		<table border="1"> <thead> <tr> <th colspan="2">线电压最大值 2/4</th> </tr> </thead> <tbody> <tr> <td>U12</td> <td>380.0 V</td> </tr> <tr> <td>2023-04-06 15:09:47</td> <td></td> </tr> <tr> <td>U23</td> <td>380.0 V</td> </tr> <tr> <td>2023-04-06 15:09:47</td> <td></td> </tr> <tr> <td>U31</td> <td>380.0 V</td> </tr> <tr> <td>2023-04-06 15:09:47</td> <td></td> </tr> </tbody> </table>	线电压最大值 2/4		U12	380.0 V	2023-04-06 15:09:47		U23	380.0 V	2023-04-06 15:09:47		U31	380.0 V	2023-04-06 15:09:47		<table border="1"> <thead> <tr> <th colspan="2">电流最大值 3/4</th> </tr> </thead> <tbody> <tr> <td>I1</td> <td>5.000 A</td> </tr> <tr> <td>2023-04-06 15:09:47</td> <td></td> </tr> <tr> <td>I2</td> <td>5.000 A</td> </tr> <tr> <td>2023-04-06 15:09:47</td> <td></td> </tr> <tr> <td>I3</td> <td>5.000 A</td> </tr> <tr> <td>2023-04-06 15:09:47</td> <td></td> </tr> </tbody> </table>	电流最大值 3/4		I1	5.000 A	2023-04-06 15:09:47		I2	5.000 A	2023-04-06 15:09:47		I3	5.000 A	2023-04-06 15:09:47		<table border="1"> <thead> <tr> <th colspan="2">Inc最大值 4/4</th> </tr> </thead> <tbody> <tr> <td>In</td> <td>1.000 A</td> </tr> <tr> <td>2023-04-06 15:09:47</td> <td></td> </tr> </tbody> </table>	Inc最大值 4/4		In	1.000 A	2023-04-06 15:09:47																									
相电压最大值 1/4																																																																											
U1	220.0 V																																																																										
2023-04-06 15:09:47																																																																											
U2	220.0 V																																																																										
2023-04-06 15:09:47																																																																											
U3	220.0 V																																																																										
2023-04-06 15:09:47																																																																											
线电压最大值 2/4																																																																											
U12	380.0 V																																																																										
2023-04-06 15:09:47																																																																											
U23	380.0 V																																																																										
2023-04-06 15:09:47																																																																											
U31	380.0 V																																																																										
2023-04-06 15:09:47																																																																											
电流最大值 3/4																																																																											
I1	5.000 A																																																																										
2023-04-06 15:09:47																																																																											
I2	5.000 A																																																																										
2023-04-06 15:09:47																																																																											
I3	5.000 A																																																																										
2023-04-06 15:09:47																																																																											
Inc最大值 4/4																																																																											
In	1.000 A																																																																										
2023-04-06 15:09:47																																																																											
退出 ↑ ↓	退出 ↑ ↓	退出 ↑ ↓	退出 ↑ ↓																																																																								
Power																																																																											
<table border="1"> <thead> <tr> <th colspan="2">有功功率最大值 1/4</th> </tr> </thead> <tbody> <tr> <td>P1</td> <td>1.100 kW</td> </tr> <tr> <td>2023-08-16 15:09:20</td> <td></td> </tr> <tr> <td>P2</td> <td>1.100 kW</td> </tr> <tr> <td>2023-08-16 15:09:25</td> <td></td> </tr> <tr> <td>P3</td> <td>1.100 kW</td> </tr> <tr> <td>2023-08-16 15:09:50</td> <td></td> </tr> <tr> <td>P</td> <td>3.300 kW</td> </tr> <tr> <td>2023-08-16 15:09:24</td> <td></td> </tr> </tbody> </table>	有功功率最大值 1/4		P1	1.100 kW	2023-08-16 15:09:20		P2	1.100 kW	2023-08-16 15:09:25		P3	1.100 kW	2023-08-16 15:09:50		P	3.300 kW	2023-08-16 15:09:24		<table border="1"> <thead> <tr> <th colspan="2">无功功率最大值 2/4</th> </tr> </thead> <tbody> <tr> <td>Q1</td> <td>0.0 var</td> </tr> <tr> <td>2023-08-16 15:09:20</td> <td></td> </tr> <tr> <td>Q2</td> <td>0.0 var</td> </tr> <tr> <td>2023-08-16 15:09:25</td> <td></td> </tr> <tr> <td>Q3</td> <td>0.0 var</td> </tr> <tr> <td>2023-08-16 15:09:50</td> <td></td> </tr> <tr> <td>Q</td> <td>0.0 var</td> </tr> <tr> <td>2023-08-16 15:09:24</td> <td></td> </tr> </tbody> </table>	无功功率最大值 2/4		Q1	0.0 var	2023-08-16 15:09:20		Q2	0.0 var	2023-08-16 15:09:25		Q3	0.0 var	2023-08-16 15:09:50		Q	0.0 var	2023-08-16 15:09:24		<table border="1"> <thead> <tr> <th colspan="2">视在功率最大值 3/4</th> </tr> </thead> <tbody> <tr> <td>S1</td> <td>1.100 kVA</td> </tr> <tr> <td>2023-08-16 15:09:20</td> <td></td> </tr> <tr> <td>S2</td> <td>1.100 kVA</td> </tr> <tr> <td>2023-08-16 15:09:25</td> <td></td> </tr> <tr> <td>S3</td> <td>1.100 kVA</td> </tr> <tr> <td>2023-08-16 15:09:50</td> <td></td> </tr> <tr> <td>S</td> <td>3.300 kVA</td> </tr> <tr> <td>2023-08-16 15:09:24</td> <td></td> </tr> </tbody> </table>	视在功率最大值 3/4		S1	1.100 kVA	2023-08-16 15:09:20		S2	1.100 kVA	2023-08-16 15:09:25		S3	1.100 kVA	2023-08-16 15:09:50		S	3.300 kVA	2023-08-16 15:09:24		<table border="1"> <thead> <tr> <th colspan="2">功率因数最大值 4/4</th> </tr> </thead> <tbody> <tr> <td>PF1</td> <td>1.000 ~~~</td> </tr> <tr> <td>2023-08-16 15:09:20</td> <td></td> </tr> <tr> <td>PF2</td> <td>1.000 ~~~</td> </tr> <tr> <td>2023-08-16 15:09:25</td> <td></td> </tr> <tr> <td>PF3</td> <td>1.000 ~~~</td> </tr> <tr> <td>2023-08-16 15:09:50</td> <td></td> </tr> <tr> <td>PF</td> <td>1.000 ~~~</td> </tr> <tr> <td>2023-08-16 15:09:24</td> <td></td> </tr> </tbody> </table>	功率因数最大值 4/4		PF1	1.000 ~~~	2023-08-16 15:09:20		PF2	1.000 ~~~	2023-08-16 15:09:25		PF3	1.000 ~~~	2023-08-16 15:09:50		PF	1.000 ~~~	2023-08-16 15:09:24	
有功功率最大值 1/4																																																																											
P1	1.100 kW																																																																										
2023-08-16 15:09:20																																																																											
P2	1.100 kW																																																																										
2023-08-16 15:09:25																																																																											
P3	1.100 kW																																																																										
2023-08-16 15:09:50																																																																											
P	3.300 kW																																																																										
2023-08-16 15:09:24																																																																											
无功功率最大值 2/4																																																																											
Q1	0.0 var																																																																										
2023-08-16 15:09:20																																																																											
Q2	0.0 var																																																																										
2023-08-16 15:09:25																																																																											
Q3	0.0 var																																																																										
2023-08-16 15:09:50																																																																											
Q	0.0 var																																																																										
2023-08-16 15:09:24																																																																											
视在功率最大值 3/4																																																																											
S1	1.100 kVA																																																																										
2023-08-16 15:09:20																																																																											
S2	1.100 kVA																																																																										
2023-08-16 15:09:25																																																																											
S3	1.100 kVA																																																																										
2023-08-16 15:09:50																																																																											
S	3.300 kVA																																																																										
2023-08-16 15:09:24																																																																											
功率因数最大值 4/4																																																																											
PF1	1.000 ~~~																																																																										
2023-08-16 15:09:20																																																																											
PF2	1.000 ~~~																																																																										
2023-08-16 15:09:25																																																																											
PF3	1.000 ~~~																																																																										
2023-08-16 15:09:50																																																																											
PF	1.000 ~~~																																																																										
2023-08-16 15:09:24																																																																											
退出 ↑ ↓	退出 ↑ ↓	退出 ↑ ↓	退出 ↑ ↓																																																																								
Harmonic																																																																											

电压总谐波最大值1/4 L1 5.753 % 2023-04-06 15:09:47 L2 5.340 % 2023-04-06 15:09:47 L3 5.742 % 2023-04-06 15:09:47 退出 ↑ ↓	电流总谐波最大值2/4 L1 10.53 % 2023-04-06 15:09:47 L2 11.50 % 2023-04-06 15:09:47 L3 10.42 % 2023-04-06 15:09:47 退出 ↑ ↓	K 因子最大值 3/4 L1 1.245 2023-04-06 15:09:47 L2 1.145 2023-04-06 15:09:47 L3 1.325 2023-04-06 15:09:47 退出 ↑ ↓	波峰因子最大值 4/4 L1 1.445 2023-04-06 15:09:47 L2 1.445 2023-04-06 15:09:47 L3 1.425 2023-04-06 15:09:47 退出 ↑ ↓
--	--	--	--

### 3.3.7 I/O Menu

Displays parameters such as DI status, DI pulse count, DO status, etc. The specific display interface is as follows:

DI 状态 1/3 DI1 打开 DI2 打开 DI3 打开 DI4 打开 退出 ↑ ↓	DI 脉冲计数 2/3 DI1 0 DI2 0 DI3 0 DI4 0 退出 ↑ ↓	DO 状态 3/3 DO1 动作 DO2 返回 退出 ↑ ↓	
---	---	---	--

### 3.3.8 Rate Menu

The rate menu is divided into eight submenus (sharp, peak, flat, valley, F5, F6, F7, F8), which display active, reactive, and apparent degrees of electricity as follows:

尖有功电度 1/3 正向 0.0 反向 0.0 退出 ↑ ↓	尖无功电度 2/3 正向 0.0 反向 0.0 退出 ↑ ↓	尖视在电度 3/3 总和 0.0 退出 ↑ ↓	
---	---	-------------------------------	--

### 3.3.9 Setup Menu

Setting menu, default password: 1000, refer to Parameter Setting for detailed settings.

输入密码 0000 退出 确认	设置 基本参数 装置维护 通信参数 测温设置 DO 参数 分时计费 DI 参数 显示参数 日期时间 退出 ↑ ↓ 确认		
-----------------------	--	--	--

### 3.4 Parameter setting menu

Parameters		Clarification	Scope/Options to be selected	Default value
Secondary menu	Three-tier menu			
Basic parameters				
Wiring Method		Setting the wiring method	3P3W/3P4W	3P4W



PT primary side		Setting the primary side rated voltage	1~1000000V	230
PT secondary side		Setting the rated voltage of the secondary side	1~690V	230
CT primary side		Setting the primary side rated current	1~30000A	5
CT secondary side		Setting the rated current of the secondary side	1~5A	5
Power Factor Algorithm		Setting the power factor algorithm	IEC/IEEE	IEC
Apparent power algorithm		Setting the apparent power algorithm	Vector/Constant	Vector
I1 Direction		Phase A current direction setting	Forward/Reverse	Forward
I2 Direction		Phase B current direction setting	Forward/Reverse	Forward
I3 Direction		Phase C current direction setting	Forward/Reverse	Forward
Harmonic calculation		Setting the harmonic calculation method	THDf/THDr	THDf

method				
Slip time		Setting the slip time	1~60	1
Duty cycle		Setting the demand cycle	1~60	15
Pulse constant		Setting the pulse constant	1000/3200	3200
Communications parameter				
Address		Setting the communication address	1~247	1
Baud		Setting the baud rate	2400/4800/9600	9600
Check digit		Setting the parity bit	No parity/ Odd parity/ Even parity	Uncalibrated
DO parameters				
DO1/DO2	Monitoring Objects	Setting up monitoring objects	U1/U2/U3/UNav/U12/U23/U31/UUav/I1/I2/I3/Iav/In/P1/P2/P3/Psum/Q1/Q2/Q3/Qsum/S1/S2/S3/Ssum/PF1/PF2/PF3/PF	NULL
	Unit	Monitoring target units		NULL

	Upper alarm value	Setting the upper limit alarm value		
	Lower bound release value	Setting the upper release value		
	Lower limit alarm value	Setting the lower limit alarm value		
	Lower bound release value	Setting the lower release value		
	Motion Delay	Setting the action delay	0~9999ms	200
	Action Type	Setting the action type	Power level/Pulse	Power level
	Pulse width	Setting the pulse width	0~9999ms	1000
DI parameters				
Filtering time		Setting the filter time	1~250ms	100
Clear Count DI1		Clear Count DI1	Yes/No	No
Clear Count DI2		Clear Count DI2	Yes/No	No
Clear Count DI3		Clear Count DI3	Yes/No	No
Clear Count DI4		Clear Count DI4	Yes/No	No
Date Time				
Time		Display device time	Like 13:50:23	

Date		Display device date	Like 2023/04/28	
Maintenance of installations				
Remove power			Yes/No	No
Removal requirement			Yes/No	No
Clarity is the best value			Yes/No	No
Clear running time			Yes/No	No
Restore Factory Settings			Yes/No	No
Time-based billing				
Table 1 on rates of payment		Setting of payment rates Table 1		
Table 2 of the rates of payment		Setting of payment rates Table 2		
Fee Schedule Switching Date	Fee Meter Switching Capability	Setting whether to switch meters	Yes/No	No
	Fee Schedule Switching Date	Setting the meter switchover date		

## After-sales service

1. If the user does not understand the description in the manual during installation and commissioning, please contact the aftersales team.
2. The company's technology is ready to answer product-related questions.
3. The problems arising in the use of the product will be replied within one working day.
4. Our company has a one-year free warranty for the above products from the date of sale.

---

Technical descriptions are subject to change without notice

Antin Power

Hangzhou Antin Power Technology Co., Ltd.

R&D headquarters: 8th floor, Lufang Science and Technology Innovation Building, Xihu District, Hangzhou City, Zhejiang Province

Intelligent manufacturing base: 4th Floor, Building 3, Block C, Qinglan Science and Technology Innovation Park, Xihu District, Hangzhou City, Zhejiang Province

Email: [sales@china-antin.com](mailto:sales@china-antin.com)

Website: <http://www.china-antin.com>